

Buildings (15)

Wall Couped with Two Arched Doorways

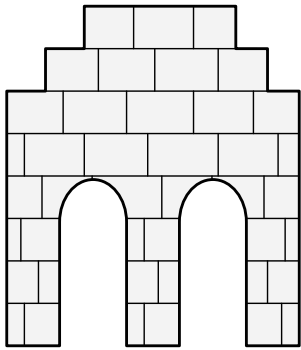

Watchtower

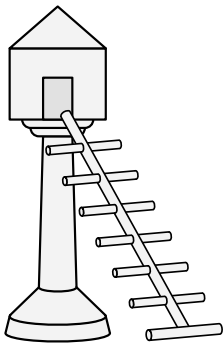

Open Well (2)

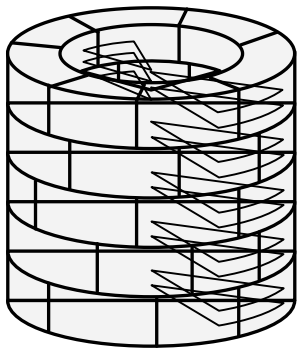

Windmill (2)

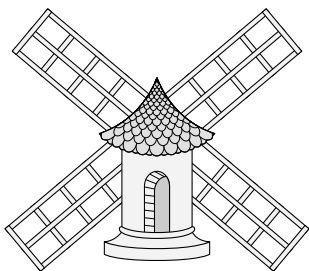

Wall Enarched

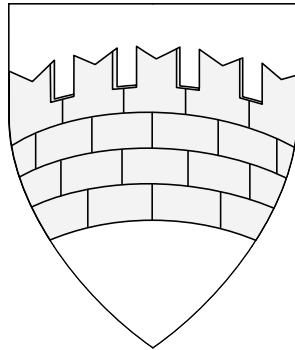

Covered Well (1)

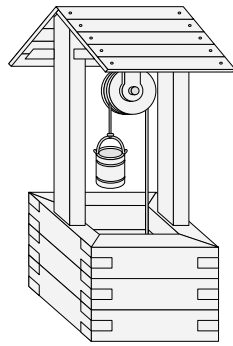

Open Well (3)

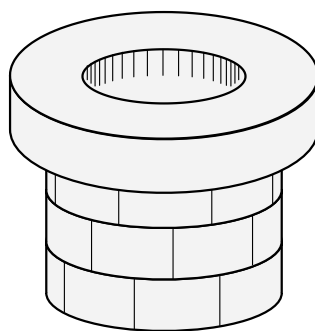

Windmill Sail

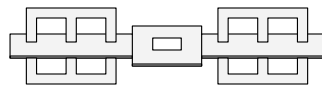

Wall Issuant From Base

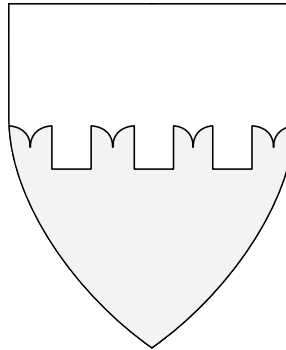

Covered Well (2)

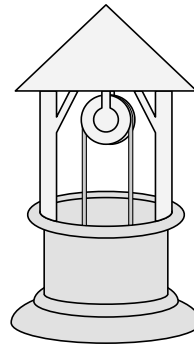

Open Well (4)

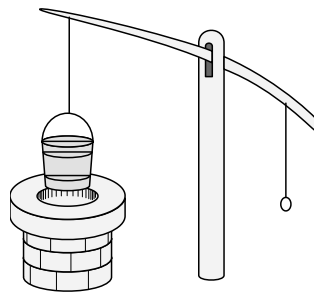

Window (1)

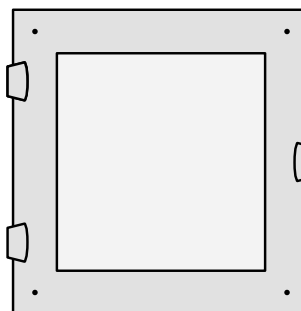

Wall Issuant From Base With Gate

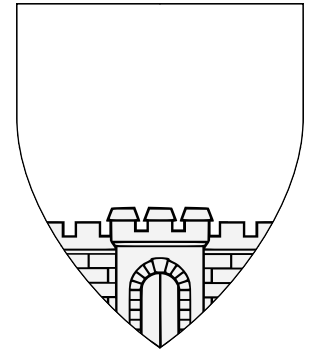

Open Well (1)

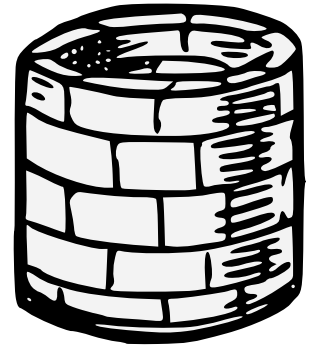

Windmill (1)

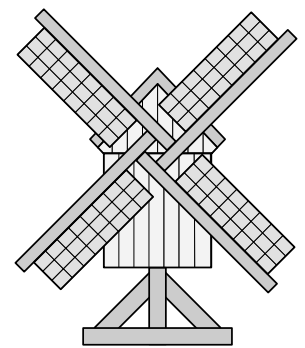

Window (2)

